

# Hurricane<sup>®</sup> PRO

**HIGH VELOCITY METAL  
WALL MOUNT FAN 20"**

**AMPS: 1.2 / WATTS: 140 / VOLT: 120**

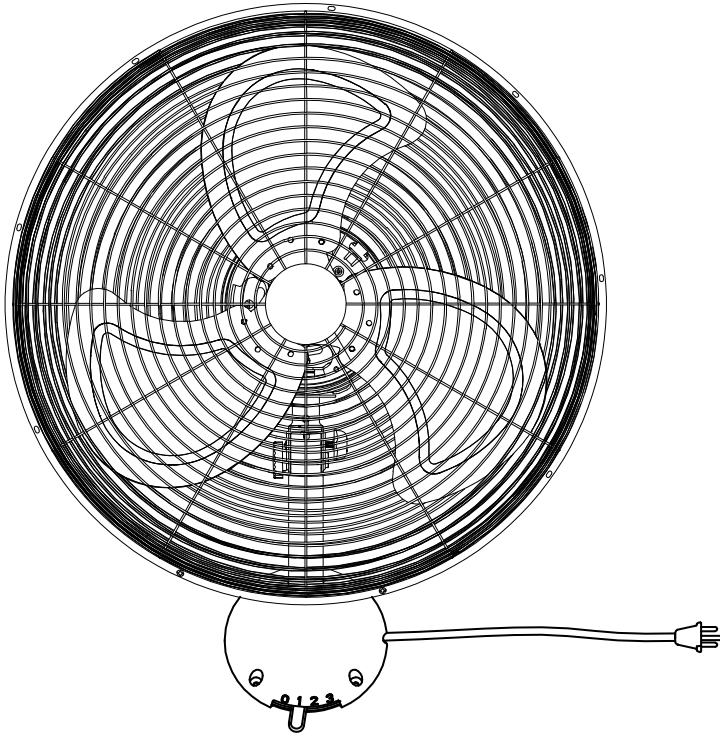

**READ AND SAVE  
THESE INSTRUCTIONS**

**HIGH VELOCITY**



## WARNING

When using electrical appliances, basic precautions should always be followed to avoid the risk of fire, electric shock and injury to persons. Including the following:

1. Only use this fan as described in this manual to reduce the risk of electrical shock or injury.
2. To protect against electrical shock, do not immerse unit plug or cord in water or spray with liquids.
3. Only plug the unit into a power outlet with the same voltage as shown on the fan specifications.
4. Keep the fan out of the reach of children.
5. Never insert fingers, pencils or any other object through the guards when fan is running.
6. High velocity fans are designed to create rapid air movement, therefore, make sure the fan is not placed near drapes, curtains or any objects that may be drawn into the fan outlet.
7. Do not operate in the presence of explosive and/or flammable fumes.
8. Unplug the power cord when moving the unit from one location to another.
9. Do not plug/unplug the fan into/from the electrical outlet with wet hand.
10. Never operate the fan without fan guard in place, as serious personal injury may result.
11. If the power cord is damaged, it must be replaced by the manufacturer or its service agent or a similarly qualified person in order to avoid a hazard.
12. Indoor use only, do not use outdoor. Do not place the fan in or near a window. Rain may create an electrical hazard.
13. To avoid unit from falling down, which could cause injury or damage, only operate the unit after it is firmly mounted on a strong flat wall surface.
14. **WARNING!** To reduce the risk of fire or electric shock, **DO NOT** use this fan with any solid-state speed control devices.
15. This product uses overload protection (fuse). A blown fuse indicates an overload or short-circuit situation. If the fuse burns out, unplug the product from the outlet. Replace the fuse as per the user servicing instructions (follow product marking for proper fuse rating) and check the products. If the replacement fuse blows, a short-circuit may be present and the product should be discarded or returned to an authorized service facility for examination and/or repair.

# INSTALLATION

1. Mount wall bracket to a stud using the three 1 $\frac{3}{4}$ " screws (included). Align the three center mounting holes with the selected wall stud (Fig. 2).

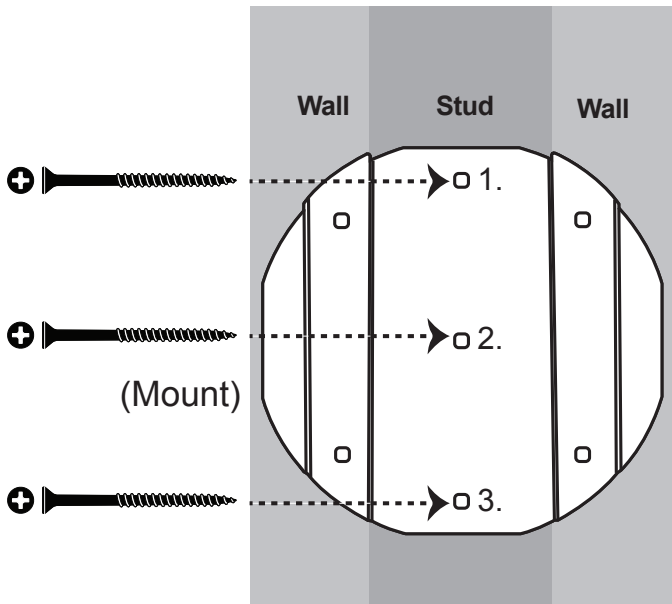

(Fig. 2)

# INSTALLATION

2. Screw in the top two fan mount screws into wall mount bracket, leaving space for the fan to hang. Carefully hang the fan using the keyholes in the top hanging points for the fan. (Fig.3).

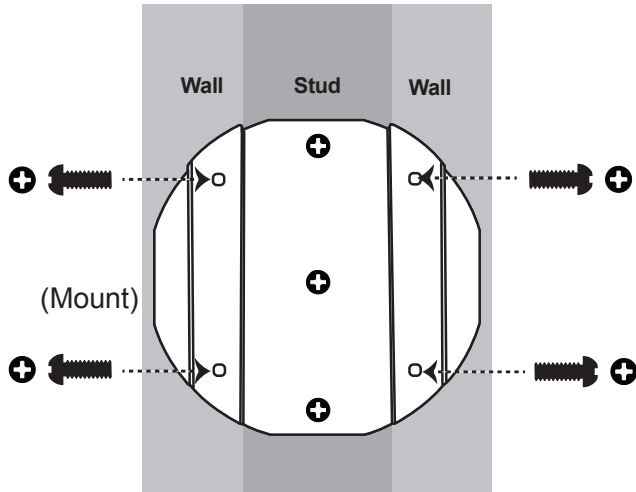

(Fig.3)

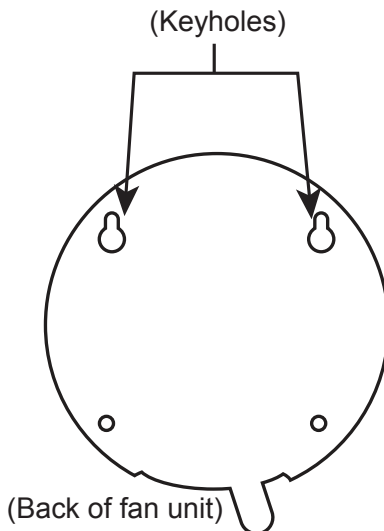

## INSTALLATION

3. Tighten down all four mounting screws securely to the wall mount bracket (Fig 4).

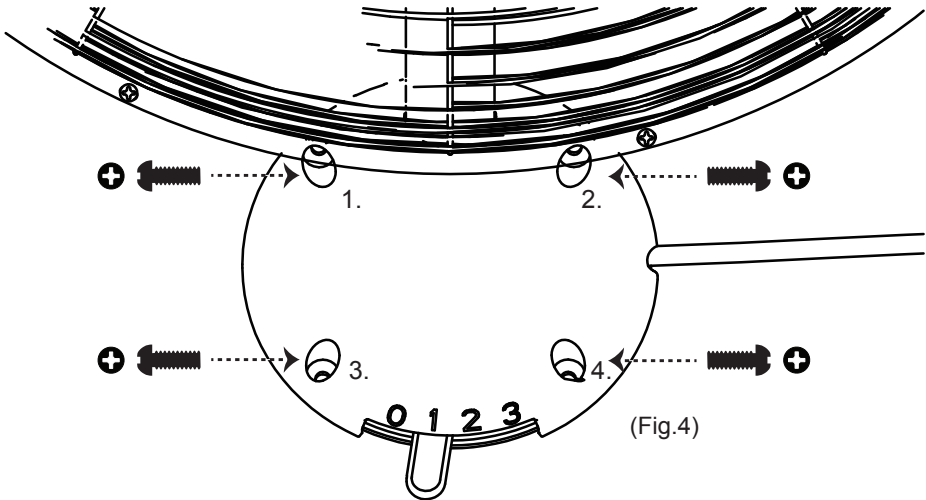

## OPERATION

The unit can be used alone or in conjunction with an air conditioner to circulate cooled air or force the air into other rooms.

1. To operate the fan, first, plug the power cord into a standard 120 volt AC outlet.
2. To adjust fan speed, slide the speed control bar located at the fan base to the desired position.  
0 — Stop 1 — Low 2 — Medium 3 — High

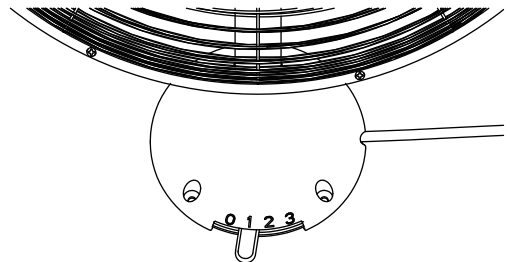

## **OSCILLATION**

To allow the fan to oscillate, push the knob down on the motor housing. Pull up the knob if oscillation is not desired.

## **FAN HEAD ADJUSTMENT**

To adjust the tilt angle of the fan head, please loosen the screw knob (as shown to the right) then turn the fan head up or down to desire angle, and then tighten the screw knob again (Fig.6).

It is normal for the motor to feel warm to touch during operation. The motor is thermally protected and will automatically shut off should it overheat for any reason. If this happens, immediately disconnect the fan from the power outlet.

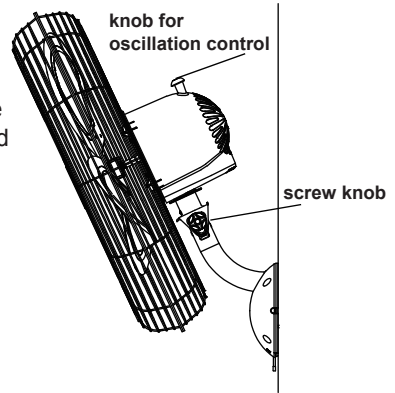

(Fig.6)

# **CLEANING / MAINTENANCE INSTRUCTIONS**

Follow these instructions to correctly and safely care for your unit.

## **ATTENTION**

1. Always unplug the fan before cleaning or disassembling.
2. DO NOT immerse the fan in water and never allow water to drip into the motor housing.
3. Be sure to use a soft cloth moistened with a mild soap solution.
4. Do not use any of the following as a cleaner: Gasoline, thinner or benzene.

## **FAN BLADE & FRONT GRILL CLEANING**

1. Use a screwdriver to remove the screws at the front grill.
2. Remove the front grill.
3. Clean the fan blade and grill with a soft damp cloth. DO NOT ATTEMPT TO REMOVE THE FAN BLADE. Do not allow the motor or other electrical components to be exposed to water.
4. Replace the front grill and secure it with the screws removed in the first step.

## **REPLACEABLE FUSE**

The plug is a safety feature, it contains a safety device (fuse), if your replaceable fuse (5 Amp, 125 Volt) blows, please follow below instructions to replace the fuse.

1. Unplug your fan, grasp plug and remove from the receptacle or other outlet device. Do not unplug by pulling on cord.
2. Slide open the fuse cover at the side of the plug by using your thumb or a flat screwdriver.
3. Remove the fuse carefully (Fig.7).
4. Put in a new 5 Amp 125 Volt fuse, make sure it is secured in place.
5. Slide back the fuse cover completely.
6. Risk of fire. Do not replace attached plug. Contains a safety device (fuse) that should not be removed. Discard product if the attached plug is damaged.

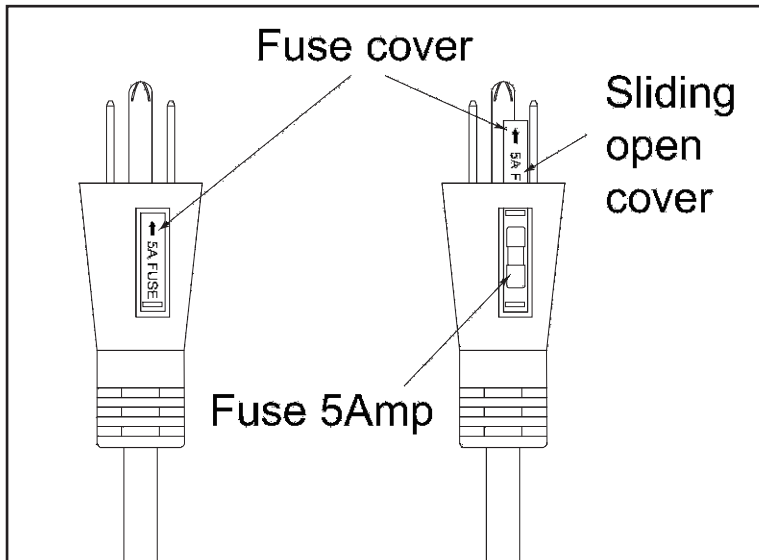
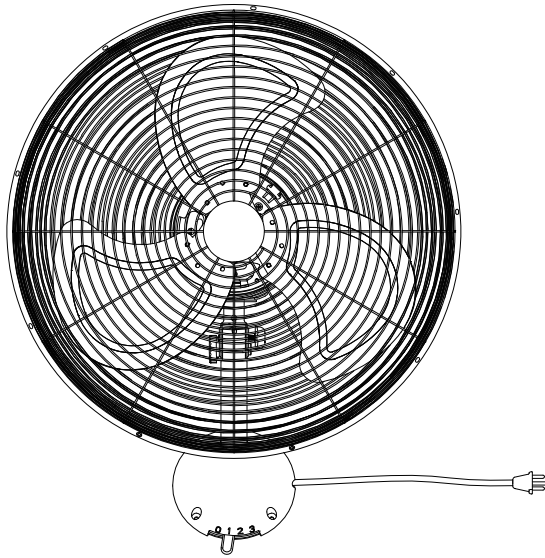

Fig.7



# Hurricane<sup>®</sup> PRO

## HIGH VELOCITY METAL WALL MOUNT FAN 20"

**Part #HGC736474**

Use a "QR Code App" on  
your smart phone to access  
our website and browse our  
entire product offering or go  
to: [www.hurricane-fans.com](http://www.hurricane-fans.com)



**Hurricane<sup>®</sup>**  
[www.hurricane-fans.com](http://www.hurricane-fans.com)

  
co

Exclusively distributed by Hawthorne Hydroponics LLC,  
a subsidiary of The Hawthorne Gardening Company,  
3204 NW 38th Circle, Vancouver, WA 98660  
**HawthorneGC.com | Canada: HawthorneGC.ca**  
©2020. World rights reserved.